

GENERAL TOLERANCE : ±0.5

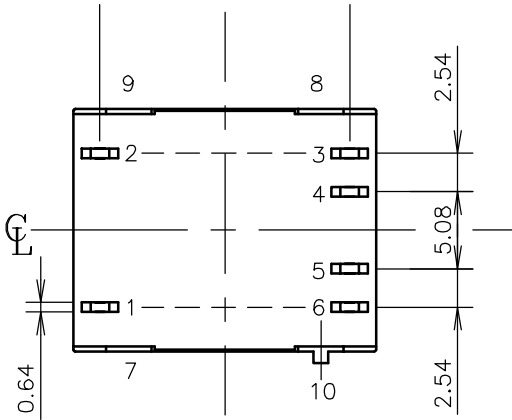

TERMINAL ASSIGNMENTS

- 1 +Vin
- 2 -Vin
- 3 -Vout
- 4 COM
- 5 TRM
- 6 +Vout

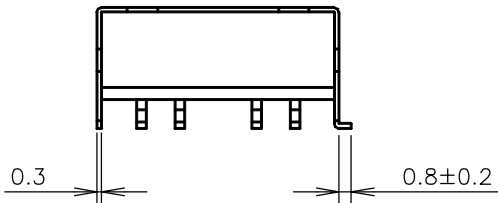
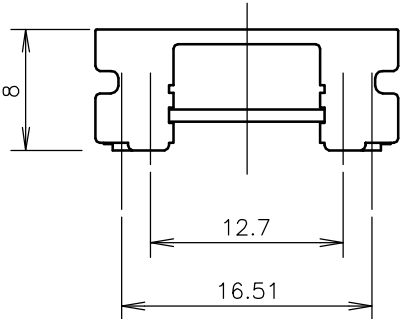
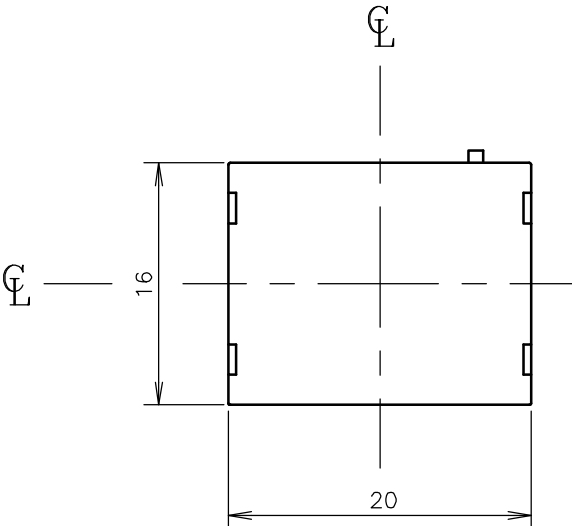
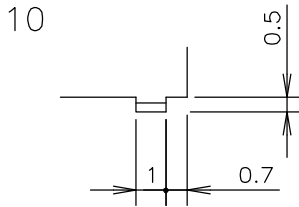
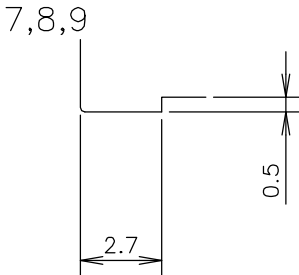
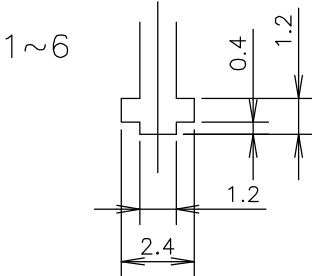

(unit : mm)

MODEL NAME	PSD1R5/S
DENSEI-LAMBDA	

C199-02-01/S